

Varenummer: 5725019311

Beskrivelse: NSK 2-huls flangeleje UCFL311D1

## Mål

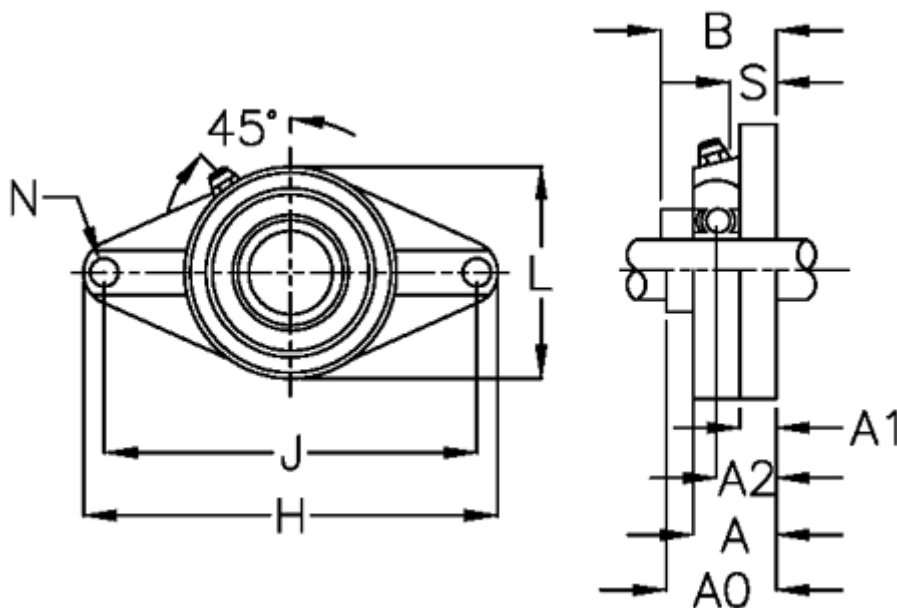

A	= 52	J	= 198
A0	= 71	L	= 150
A1	= 20	N	= 25
A2	= 30	S	= 25
Aksel Ø	= 55		
B	= 66		
Bolt str.	= M22		
H	= 250		